



RadioShack®

www.radioshack.comSM



**2-Line 900MHz Cordless
Answering Machine
with Speakerphone**



Owner's Manual
Please read before using this equipment.

This telephone has been tested and found to comply with all applicable UL and FCC standards.

WARNING: To reduce the risk of fire or shock hazard, do not expose this product to rain or moisture.

	CAUTION RISK OF ELECTRIC SHOCK. DO NOT OPEN.	
CAUTION: TO REDUCE THE RISK OF ELECTRIC SHOCK, DO NOT REMOVE COVER OR BACK. NO USER-SERVICEABLE PARTS INSIDE. REFER SERVICING TO QUALIFIED PERSONNEL.		



This symbol is intended to alert you to the presence of uninsulated dangerous voltage within the product's enclosure that might be of sufficient magnitude to constitute a risk of electric shock. Do not open the product's case.



This symbol is intended to inform you that important operating and maintenance instructions are included in the literature accompanying this product.

□ Contents

Contents	3
Features	5
Read This Before Installation	7
Important Safety Instructions	7
A Quick Look At Your Telephone	10
Installation	10
Mounting the Phone	10
Connecting to Phone Lines	11
On a Desk Top	11
On a Wall Plate or a Wall	12
Connecting and Charging the Battery Pack	13
Setting the Dialing Mode	14
Adjusting the Ringer	14
On the Handset	14
On the Base	14
Setting the Number of Rings	15
Setting the Day/Time	15
Basic Operation	15
Making a Call	15
Answering a Call	16
Setting the Handset Volume	16
Adjusting the Speakerphone Volume	16
Using Mute	16
Using HOLD	17
Switching Between the Handset and Speakerphone	17
Using Both the Handset and Speakerphone	17
Making a Conference Call	17
3-Way Conferencing	17
4-Way Conferencing	18
Using the Phone with Extension Phones	18
Using REDIAL	18
Using FLASH	18
Using Tone Services On a Pulse Line	19
Using the Paging/Intercom Features	19
Using a Headset	20

Memory Operation	20
Storing a Number in Memory	20
Entering a Pause	21
Dialing a Memory Number	21
Chain-Dialing Service Numbers	21
Testing Stored Emergency Numbers	21
TAD Operation	22
Selecting the Outgoing Message	22
Recording/Deleting an Outgoing Message	22
Setting the Record Time	22
Setting the Phone to Answer Calls	23
Screening Calls	23
Recording Incoming Messages	23
Recording a Memo	24
Recording a Conversation	24
Playing Messages	24
Adjusting the TAD's Volume	25
Deleting Messages	25
Setting the Remote Operation PIN	25
Remote Operation	26
Using the Toll-Saver	26
Using Remote Commands	26
Troubleshooting	28
Care	29
Replacing the Battery Pack	30
The FCC Wants You to Know	31
Lightning	31

□ **Features**

Your RadioShack 2-Line 900MHz Cordless Answering Machine uses advanced cordless telephone technology to give you extended range and superior audio quality, with less interference than many other cordless phones. The phone lets you make and receive calls on two separate telephone lines.

The answering system stores up to 25 minutes or up to 59 messages on a computer chip and records each message's day and time. This gives you advanced capabilities over tape-based answering machines:

- you can delete individual messages and save the rest.
- there are no tapes to bother with and no tape mechanisms to wear out.

The remote operation feature lets you operate your TAD from a touch-tone phone (or from a rotary phone with a pocket tone dialer).

Its features include:

TELEPHONE FEATURES

Two-Line Telephone System — lets you easily handle two telephone lines at the same time. You can use both lines to make 3- or 4-way conference calls, or use one line for data communication while you are talking on the other.

Speakerphone — lets you answer calls without using the handset.

Headset Jack — lets you make or answer calls with handsfree convenience using an optional headset.

10-Number Memory Dialing — lets you store up to 10 numbers in memory for easy dialing.

Ample Talk and Standby Time — the supplied battery pack provides 7 hours of continuous talk time or 7 days of standby time (when fully charged).

Paging/Two-Way Intercom System — lets you send a signal from the base to the handset, or from the handset to the base, to page someone or locate the handset when it is away from the base. If someone answers, you can use the phone as an intercom.

Dual Volume Controls — let you adjust the volume you hear through the handset and speakerphone.

Adjustable Ringer — lets you choose high or low volume for both lines' ringers.

Wall Mountable — you can mount the phone on the wall to save space on your desk top.

Facedown or Faceup Handset Charging — you can place the handset on the base facedown or faceup.

40 Channels — automatically selects a clear channel when you make or answer a call.

Security Access-Protection Code — automatically prevents other cordless

phone users from using your phone line while the handset is off the base.

Line Status Indicators — show if a line is available, in use, or on hold.

Redial — lets you quickly redial the last number dialed.

Flash — sends an electronic switch-hook signal for use with special phone services, such as Call Waiting.

Tone/Pulse Dialing — lets you use your phone with either type of service, and you can easily switch from pulse to tone dialing for long-distance, bank-by-phone, or other special services.

Hearing-Aid Compatibility — lets you use your phone with hearing aids that have a T (telephone) switch.

TAD FEATURES

Call Screening — lets you listen as a caller leaves a message so you can decide whether or not to answer the call.

Day/Time Stamp — records the day and time each message was recorded.

Two-Line System — records incoming messages separately for Line 1 and Line 2.

Two Prerecorded Messages — gives you the option of using one of two pre-recorded outgoing messages or recording your own.

Adjustable Incoming Message Recording Time — lets you set the TAD to record one minute or four minutes. You can set for each line separately.

Announcement Only — lets you play an announcement for callers to hear, without recording their messages.

Message-Counter — shows the number of messages the TAD has recorded.

Programmable PIN — you can set a two-digit personal identification number (PIN) for secure remote operation.

Memo Recording — lets you leave messages for yourself or others in your home or office. You can also record your phone conversation.

Important: Every state has different regulations governing the recording of conversations over the telephone. Be sure to check your local, state and federal laws before using this product to record any telephone conversation in order to determine that your use is in compliance with such laws or guidelines.

Phone Pick-Up Detection — stops recording when you pick up any phone on the same line as the phone, and resets to answer the next call.

Adjustable Ring Number — lets you set the TAD to answer after three or five rings, or use Toll Saver to avoid unnecessary charges when you call by long distance to check your messages.

Digital Volume Control — lets you precisely adjust the speakerphone and message playback.

Important:

- Cordless phones such as this one require AC power to operate. When the AC power is off, you cannot dial out or receive incoming calls using your phone. To be safe, you should

also have a corded phone that does not need AC power to operate so you can still make and receive calls if there is an AC power failure.

- When AC power is lost, the phone loses the security access-protection code connection between the base and the handset. When power is restored, put the handset on the base briefly to restore this connection so you can use the handset.

READ THIS BEFORE INSTALLATION

We have designed your telephone to conform to federal regulations, and you can connect it to most telephone lines. However, each telephone (and each device, such as an answering machine) that you connect to the telephone line draws power from the telephone line. We refer to this power draw as the device's ringer equivalence number, or REN. The REN is on the bottom of your telephone.

If you use more than one phone or other device on the line, add up all of the RENs. If the total is more than five (or three in rural areas), your telephones might not ring. If ringer operation is impaired, remove a device from the line.

Your telephone complies with Part 68 of *FCC Rules*. You must, upon request, provide the FCC registration number and the REN to your telephone company. Both numbers are on the bottom of your telephone.

Note: You must not connect your telephone to:

- coin-operated systems
- party-line systems
- most electronic key telephone systems

This equipment complies with the limits for a Class B digital device as specified in Part 15 of *FCC Rules*. These limits provide reasonable protection against radio and TV interference in a residential area. However, your equipment might cause TV or radio interference even when it is operating properly. To eliminate interference, you can try one or more of the following corrective measures:

- reorient or relocate the receiving antenna
- increase the distance between the equipment and the radio or TV
- use outlets on different electrical circuits for the equipment and the radio or TV

Consult your local RadioShack store if the problem still exists.

You must use shielded interface cables with this equipment.

IMPORTANT SAFETY INSTRUCTIONS

When using your telephone equipment, basic safety precautions should always be followed to reduce the risk of fire, electric shock and injury to persons, including the following:

1. Read and understand all instructions.

2. Follow all warnings and instructions marked on the product.
3. Never install telephone wiring during a lightning storm.
4. Never install telephone jacks in wet locations unless the jack is specifically designed for wet locations.
5. Never touch uninstalled telephone wires or terminals unless the telephone line has been disconnected at the network interface.
6. Use caution when installing or modifying telephone lines.
7. Do not fix the AC power supply cord to building surfaces with metal fittings (if the product has an AC power cord).
8. Unplug this product from the wall outlet before cleaning. Do not use liquid cleaners or aerosol cleaners. Use a damp cloth for cleaning.
9. Do not use this product near water, for example, near a bath tub, wash bowl, kitchen sink, or laundry tub, in a wet basement, or near a swimming pool.
10. Do not place this product on an unstable cart, stand, or table. The product may fall, causing serious damage to the product.
11. Slots and openings in the cabinet and the back or bottom are provided for ventilation. To protect it from overheating, these openings must not be blocked or covered. The openings should never be blocked by placing the product on a bed, sofa, rug, or other similar surface. This product should never be placed near or over a radiator or heat register. This product should not be placed in a built-in installation unless proper ventilation is provided.
12. This product should be operated only from the type of power source indicated on the marking label. If you are not sure of the type of power supply to your home, consult your local power company.
13. Do not allow anything to rest on the power cord. Do not locate this product where the cord will be stepped on.
14. Do not overload wall outlets and extension cords as this can result in a risk of fire or electric shock.
15. Never push objects of any kind into this product through cabinet slots as they may touch dangerous voltage points or short out parts that could result in a risk of fire or electric shock. Never spill liquid of any kind on the product.
16. To reduce the risk of electric shock, do not disassemble this product. Take it to a qualified service technician when service or repair work is required. Opening or removing covers may expose you to dangerous voltage or other risks. Incorrect reassemble can cause electric shock when the product is subsequently used.
17. Unplug this product from the wall outlet and refer servicing to qualified service personnel under the following conditions:
 - A. When the power cord plug is damaged or frayed.

B. If liquid has been spilled, into the product.

C. If the product has been exposed to rain or water.

D. If the product does not operate normally by following the operating instructions. Adjust only those controls that are covered by the operating instructions because improper adjustment of other controls may result in damage and will often require extensive work by a qualified technician to restore the product to normal operation.

E. If the product has been dropped or the cabinet has been damaged.

F. If the product exhibits a distinct change in performance.

18. Avoid using a telephone (other than a cordless type) during an electrical storm. There may be a remote risk of electric shock from lightning.

19. Do not use the telephone to report a gas leak in the vicinity of the leak.

CAUTION: TO REDUCE THE RISK OF FIRE OR INJURY, READ AND FOLLOW THESE INSTRUCTIONS.

1. Use only the appropriate type and size battery pack specified in the instruction manual provided for this product.

2. Do not dispose of the battery pack in a fire. The cell may explode. Check with local codes for possible special disposal instructions.

3. Do not open or mutilate the battery pack. Released electrolyte is corro-

sive and may cause damage to the eyes or skin. It may be toxic if swallowed.

4. Exercise care in handling the battery pack in order not to short it with conducting materials such as rings, bracelets, and keys. The battery or conductor may overheat and cause burns.

5. Charge the battery pack provided or identified for use with this product only in accordance with the instructions and limitations specified in the instruction manual provided for this product.

6. Observe proper polarity orientation between the battery pack and battery charger.

SAVE THESE INSTRUCTIONS

□ *A Quick Look At Your Telephone*

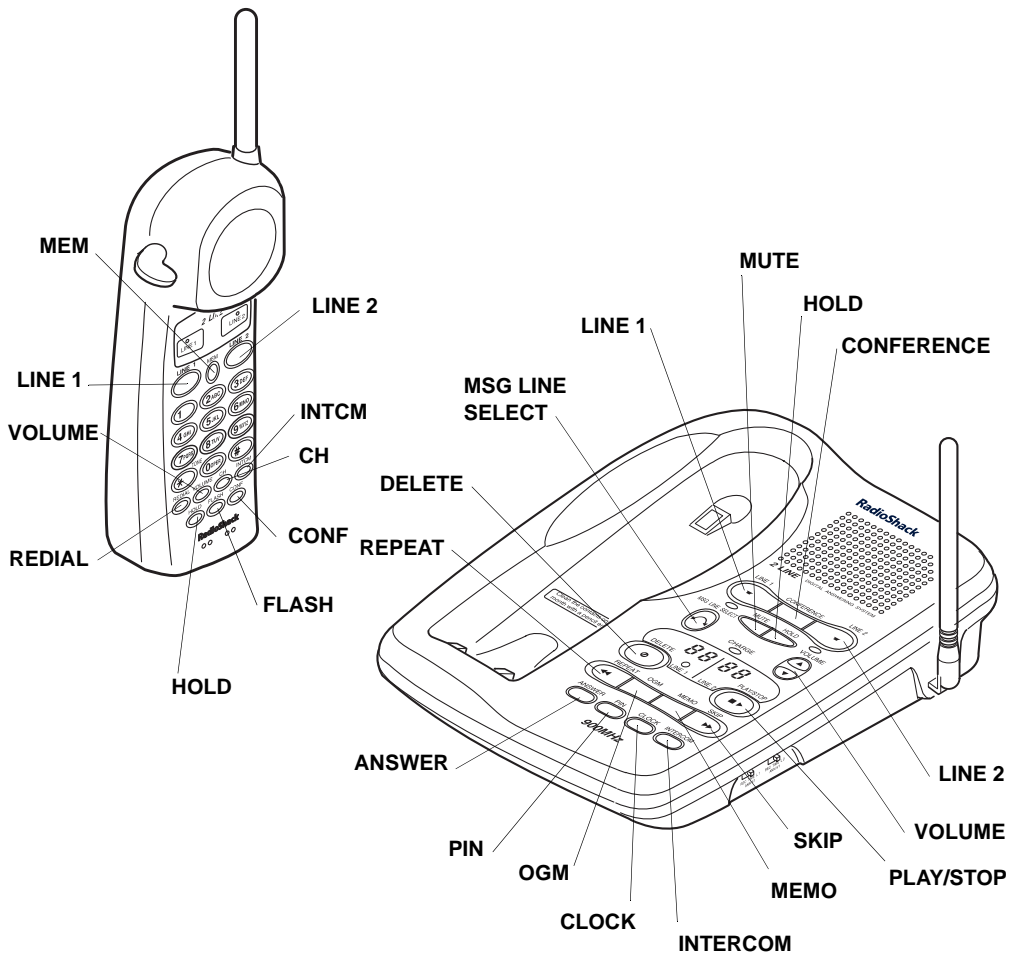

□ *Installation*

MOUNTING THE PHONE

You can place the phone's base on a desk or table, or mount it on a standard wall plate or directly on a wall. Choose a location that is:

- near an accessible AC outlet
- near a modular telephone jack

- out of the way of normal activities
- away from electrical machinery, electrical appliances, metal walls or filing cabinets, wireless intercoms, alarms, and room monitors
- away from other cordless phones

The base's location affects the handset's range. If you have a choice of several locations, try each to see which provides the best performance.

Caution: The supplied AC adapter was designed specifically for your phone. Use only the supplied adapter.

Connecting to Phone Lines

To take full advantage of the phone's capabilities, you must have two phone lines with separate phone numbers. If you have only one line, you can order a second line from your phone company.

You can connect the phone to the lines in one of these ways:

- connect two lines through a two-line modular phone jack
- connect two lines through two one-line modular phone jacks
- connect one line through a one-line modular phone jack

Notes:

- Your phone connects directly to a modular phone jack. If your phone wiring does not have a modular jack, you can update it using jacks and adapters available at your local RadioShack store. Or, you can have the phone company update it for you.

- The line that connects a two-line phone jack to the phone company wiring must be twisted-pair cable. Otherwise, you might hear interference (crosstalk) between the two lines.
- The USOC number of the two-line jack to be installed is RJ14C (RJ14W for a wall plate). The USOC number of a single-line jack is RJ11C.

On a Desk Top

1. To connect the phone to a two-line phone jack, plug one end of the supplied long two-line modular cord into **TEL LINE 1/2** on the back of the phone.

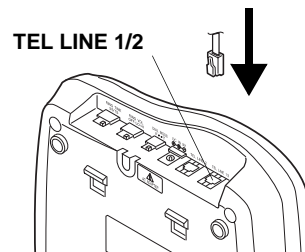

Note: If you connect the phone to a two-line phone jack with a two-line cord, do not connect another (third) phone line to **TEL LINE 2** or the phone will not operate properly. Instead, you can connect another phone device, such as a fax machine or modem.

To connect the phone to two one-line phone jacks, plug one end of the supplied long two-line modular cord into **TEL LINE 1/2** and plug another cord (not supplied) into **TEL LINE 2**.

To connect the phone to a single one-line phone jack, plug one end of the supplied long modular cord into **TEL LINE 1/2** or **TEL LINE 2**.

Note: If you connect the phone to a single one-line phone jack, avoid pressing the unused line button or you might hear feedback.

2. Plug the supplied AC adapter's barrel plug into **DC IN 9V** on the back of the base.

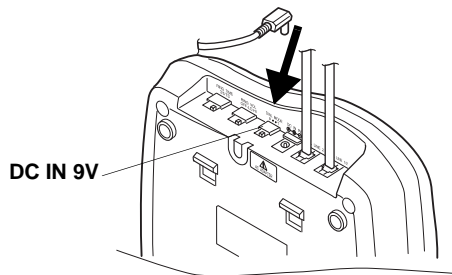

3. Route the adapter's cord through the strain relief slot on the bottom of the base.
4. Plug the adapter into a standard AC outlet.
5. Connect the phone cord(s) to the modular phone jack(s).
6. Raise the base's antenna to a vertical position.

On a Wall Plate or a Wall

Note: To mount the base directly on the wall, you need two screws (not supplied) with heads that fit into the keyhole slots on the bottom of the bracket.

1. Drill two holes $3^{15}/16$ inches apart. Then thread a screw into each hole,

letting the heads extend about $5/16$ inch from the wall.

2. Insert the two tabs at the top of the wide end of the supplied bracket into the base's lower tab slots as shown, then press down on the bracket's latches and insert them into the clip slots.

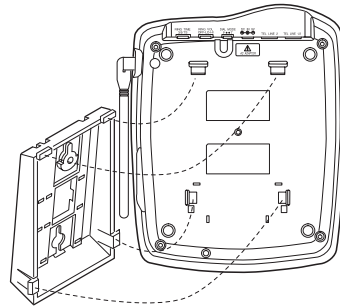

3. Connect the phone line as described in "On a Desk Top" on Page 11.
4. Insert the supplied AC adapter's barrel plug into **DC IN 9V** on the back of the base.
5. Route the adapter's cord through the narrow groove on the bracket. If you are using two phone cords, route the second cord through one of the wide grooves on the bracket.
6. *To mount the phone on a wall plate*, plug the other end of the short modular cord into the wall plate jack, then align the bracket's keyhole slots with the wall plate studs and slide the base downward to secure it. If you are using two phone cords, plug the second cord into the second phone jack.

To mount the phone directly on a wall, align the bracket's keyhole

slots with the mounted screws and slide the base downward to secure it. Connect the phone cord(s) to the modular phone jack(s).

7. Plug the adapter into a standard AC outlet.
8. Press and lift out the handset holder, flip it over as shown, then snap it back into place.

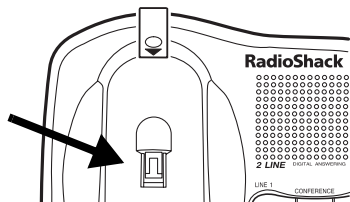

9. Raise the base's antenna to a vertical position.

CONNECTING AND CHARGING THE BATTERY PACK

Your phone comes with a rechargeable nickel-cadmium battery pack installed in the handset, but not connected. Before using your phone, you must connect the battery pack, then charge it for about 24 hours.

1. Press down and slide off the battery pack compartment cover.

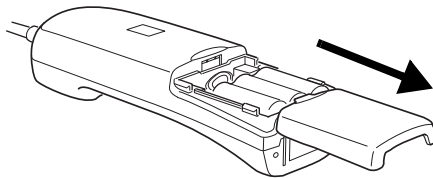

2. Lift the battery pack out of the compartment. Plug the battery pack's connector into the socket in the

compartment. The connector fits only one way.

3. Put the battery pack in the compartment.
4. Replace the cover.

To charge the battery pack, simply place the handset on the base, facing either up or down. The CHARGE indicator on the base lights.

Important: Be sure the battery pack is properly connected before you try to charge it. The CHARGE indicator lights when the handset is on the base, even if the battery pack is not connected.

Notes:

- When you first use the phone after charging or recharging the battery pack, the phone might not work and you might hear a five-beep error signal when you press **LINE 1** or **LINE 2**. If this happens, return the handset to the base for about 5 seconds. This resets the security access-protection code.
- Using a pencil eraser, clean the charging contacts on the handset and the base about once a month.
- If the phone does not work, try recharging the battery pack. (The battery power might be too low to flash the line indicators.)
- If the battery pack becomes weak during a call, the handset beeps every 3 seconds. When this happens, you cannot make another call on the phone until you recharge the battery pack.

- About once a month, fully discharge the battery pack by keeping the handset off the base until the line indicators flash. Otherwise, the battery pack loses its ability to fully recharge.
- If the battery pack is completely discharged or the base loses power while the handset is away from it, place the handset on the base to reset the security access-protection code. If it was the handset that lost power, recharge the battery pack.
- The supplied battery pack should last about one year. When it loses its ability to fully recharge, order a replacement battery pack through your local RadioShack Store (see Replacing the battery pack).

SETTING THE DIALING MODE

Set **DIAL MODE** on the back of the base for the type of service you have. If you are not sure which type you have, do this test.

1. Be sure **DIAL MODE** is set to **T** (tone).
2. Press **LINE 1** on the handset. Then listen for the dial tone.
3. Press any number other than **0**.

Note: If your phone system requires that you dial an access code (**9**, for example) before you dial an outside number, do not press the access code either.

If the dial tone stops, that line has tone service. If the dial tone continues, that line has pulse service.

4. Press **LINE 2**, listen for the dial tone, and repeat Step 3.

If you have tone service on both lines, leave **DIAL MODE** set to **T**.

If you have pulse service on either line, set **DIAL MODE** to **P** (pulse). You can use tone services on the line which supports them by pressing ***/TONE** before any other keys.

ADJUSTING THE RINGER

The phone lets you control its base and handset ringer volumes separately. You can choose a high or low ringer setting for the base or the handset.

On the Handset

At any time except during a call, repeatedly press **VOLUME** to change the ringer's volume.

On the Base

Set **RING VOL** on the back of the base to **OFF**, **LO**, or **HI**. With **RING VOL** set to **OFF**, the base's ringer does not sound when a call is received, but the handset when it is off the base (and any other phone connected to the same line) still rings.

Note: The **RING VOL** setting on the base is common to both lines.

SETTING THE NUMBER OF RINGS

Set **RING TIME** on the back of the base to **3**, **5**, or **TS** (toll-saver) to select how long the phone waits to answer a call (3 rings, 5 rings, or toll-saver).

Notes:

- If you plan to check messages by long distance, set **RING TIME** to **TS** (see “Using the Toll-Saver” on Page 26).
- The ring time setting is common to both lines.

SETTING THE DAY/TIME

You must set the day of the week and time so the phone can record the correct day and time of each message.

Notes:

- Enter each keypress within about 2 minutes. Otherwise, the phone exits the time setting process and you must begin again with Step 1.
- If a call is received during the setup process, the phone exits the time setting process. Begin again with Step 1.

1. Hold down **CLOCK** until the phone beeps. The phone announces the currently set day and displays the day's number (0 for Sunday, 1 for Monday, and so on).
2. To change the day of the week, repeatedly press **SKIP** to move forward or **REPEAT** to move backward. To set the correct day of the week when it displays, press **CLOCK**.
3. The phone announces the hour. To change the hour, repeatedly press or hold down **SKIP** or **REPEAT**. To set the correct hour when it displays, press **CLOCK**.
4. The phone announces the minutes. To change the minutes, repeatedly press or hold down **SKIP** or **REPEAT**. To set the correct minutes when they display, press **CLOCK**.
5. The phone announces “AM” or “PM,” and **A** or **P** appears. Press **SKIP** or **REPEAT** to change this setting. Press **CLOCK** again to set AM or PM.
6. To check the day and time, press **CLOCK**. The phone announces the currently set day and time.

Note: When power fails, the clock retains the current time. When the power is restored, it starts counting again from the time the power failed.

□ Basic Operation

MAKING A CALL

To make a call, lift the handset from the base and press **LINE 1** or **LINE 2**, then dial the number. When you press a line

button on the handset, the **LINE 1** or **LINE 2** indicator on the handset lights. The **LINE 1** or **LINE 2** indicator on the base flashes to show that someone is using that line at the handset.

Note: If the LINE 1 or LINE 2 indicator flashes, someone is using that line at the base or on an extension phone. Press the other line button.

To end a call, press **LINE 1** or **LINE 2** on the handset or place the handset on the base.

ANSWERING A CALL

When a call comes in, the line indicator for that line flashes.

Note: To help you tell which line is ringing, each line has a distinctive ring tone.

To answer a call using the handset, lift the handset from the base and press the line button for the line that is ringing. If the handset is away from the base, press any key to answer a call.

To answer a call using the speakerphone, press either **LINE 1** or **LINE 2** (whichever is flashing). The indicator for the line in use lights on the base. The indicator for the same line flashes on the handset as a reminder that the line is in use.

To end a speakerphone call, press **LINE 1** (or **LINE 2**) again. The line indicator turns off.

If you receive a call on one line while talking on the other, you hear the base ring and three ring tones through the handset (or a low ring on the base when using the speakerphone) if you have set **RING VOL** to **HI** or **LO**. Press the line button for the incoming call's line. The current call is automatically placed on hold.

If both lines have an incoming call, pressing a key answers the line that began ringing first.

SETTING THE HANDSET VOLUME

You can adjust the handset's volume to any of four settings (low, mid, high, maximum). To change the handset's volume during a call, repeatedly press **VOLUME** on the handset. The setting remains the same even when you hang up the phone.

ADJUSTING THE SPEAKERPHONE VOLUME

To set the speakerphone's volume, press **VOLUME** **▲** or **▼** on the base. The display shows the volume setting in the range of **1** (lowest) to **10** (highest).

USING MUTE

While talking on the speakerphone, you can temporarily turn off the phone's microphone by pressing **MUTE** so the other party cannot hear you. The indicator for a muted line flashes red. Press **MUTE** again to resume your conversation.

Hint: If the phone is close to loud noises while you are using the speakerphone, the phone might not switch to let you hear the person on the other end of the line. If this happens, press **MUTE** to turn off the microphone so you can hear the caller. Press **MUTE** again when it is your turn to speak.

USING HOLD

Press **HOLD** to place a call on hold. The indicator for that line lights red on the base. While a call is on hold, you can temporarily place the handset on the base or use the other phone line without disconnecting the current call.

To release a line from hold and continue your conversation, press that line's button on the handset or base. You can also release a call from hold by lifting the handset if the handset is on the base, or picking up an extension phone.

To release a line that was placed on hold using another keypad (handset, base, or an extension phone), press that line's button twice.

Note: Pressing **HOLD** again while a call is on hold does not release the hold. Press the line button that is on hold.

SWITCHING BETWEEN THE HANDSET AND SPEAKERPHONE

To switch to the speakerphone while you are using the handset, press **HOLD** on the handset, then press **LINE 1** or **LINE 2** on the base.

To switch to the handset while you are using the speakerphone, lift the handset off the base. Or, if the handset is off the base, press **HOLD** on the base, then press **LINE 1** or **LINE 2** on the handset.

USING BOTH THE HANDSET AND SPEAKERPHONE

To use the handset to join a call at the base, or to use the base to join a conversation at the handset, press the line button for the line that is in use. You hear a busy tone. Before the tone ends, press the line button again.

During the call, one of you can hang up and the call can continue. To end the call, you must hang up both the base and handset.

Note: If you hear a high-pitched noise from the base's speaker, the handset and the base are too close together.

To talk with two parties using both lines, see "4-Way Conferencing" on Page 18.

MAKING A CONFERENCE CALL

3-Way Conferencing

Follow these steps to use both phone lines to set up a 3-way call. The procedure is the same for the handset and the base.

1. Place the first call on hold.
2. Answer a call on the other line.
3. Once you have the second party on the line, press **CONFERENCE (CONF)** on the handset) to bring in the first party. Both line indicators on the base light green.

4. To end the conference call, press one line button, then the other. If you want to hang up one line and continue talking on the other, press the line button you want to hang up.
5. If you want to talk on one line without disconnecting the other, press **HOLD**, then the button for the line you want to talk on. To return to a 3-way conversation, press **CONFERENCE** or **CONF**.

4-Way Conferencing

Follow these steps to use both lines and the phone's intercom function to set up a four-way call (see "Using the Paging/Intercom Features" on Page 19).

1. Make a 3-way conference call. (See "3-Way Conferencing" on Page 17).
2. Press **INTCM** on the handset or **INTERCOM** on the base to page the other keypad.

The two outside lines are automatically put on hold, but the parties on both lines can talk with each other.

3. To answer the page, press **INTCM** on the handset or **INTERCOM** on the base, then press **CONF** on the handset or **CONFERENCE** on the base.
4. To end the conference call, press **LINE 1** then **LINE 2** on one keypad, then press **LINE 2** on the other keypad.

If you want to hang up one line and continue talking on the other, press the line button that you want to hang up.

Note: You can also make a conference call using both the phone and an extension phone (see "Using the Phone with Extension Phones").

USING THE PHONE WITH EXTENSION PHONES

The phone detects when an extension phone is in use, and the corresponding line indicator flashes on the base.

To join the conversation from the handset or base, press the line button for the line in use. You hear a busy tone. Before the tone ends, press the line button again.

Note: If you hang up the phone and someone is still on that line on an extension, the phone's line indicator(s) might not stay lit.

USING REDIAL

You can quickly dial the last number dialed on either line. Press **LINE 1** or **LINE 2** then press **REDIAL** on the handset.

Notes:

- The redial memory is common to both lines. You can redial the number you originally dialed on Line 1 using Line 2.
- The redial memory holds up to 32 digits, so you can redial long distance as well as local numbers.

USING FLASH

FLASH performs the electronic equivalent of a switchhook operation for special services, such as Call Waiting.

For example, if you have Call Waiting, press **FLASH** to answer an incoming call without disconnecting the current call. Press **FLASH** again to return to the first call.

Note: If you do not have any special services, pressing **FLASH** might disconnect the current call.

USING TONE SERVICES ON A PULSE LINE

Some special services, such as bank-by-phone, require tone signals. If you have pulse service, you can still use these special tone services by following these steps.

1. Be sure **DIAL MODE** is set to **P**.
2. Dial the service's main number.
3. When the service answers, press ***/TONE**. Any additional numbers you dial are sent as tone signals.
4. After you complete the call, the phone automatically resets to the pulse mode when you hang up.

USING THE PAGING/INTERCOM FEATURES

You can use the phone as a two-way pager and intercom between the base and the handset. This is useful if the handset is away from the base and you want to locate it, or if you want to have a conversation between the handset and the base.

To page the handset from the base, press **INTERCOM**. The handset and base ring, and the CHARGE indicator on

the base flashes. Press **INTCM** on the handset to answer the page. Both LINE 1 and LINE 2 indicators on the handset stay lit and the CHARGE indicator on the base stays lit.

To page the base from the handset, press **INTCM**. The base and handset ring, and the CHARGE indicator flashes. Press **INTERCOM** on the base to answer the page. Both LINE 1 and LINE 2 indicators on the handset stay lit and the CHARGE indicator on the base stays lit.

Note: The paging ends in one minute if nobody answers. Press **INTERCOM** or **INTCM** again.

To end an intercom call, press **INTCM** or **INTERCOM**.

During a call, you can page someone at either the base or the handset to join the conversation. Press **INTERCOM** or **INTCM**. The current call is put on hold.

- To transfer the call, press **INTERCOM** or **INTCM** again when the person at the base or handset answers.
- To start a 3-way call, tell the person at the base or handset to press the line button for the call, then press the same button twice on your keypad when they answer the page.

Notes:

- You cannot page the base or handset if it is already in use. A busy tone sounds.
- If a call comes in during an intercom conversation, either of the intercom parties can answer the call as they

normally would by pressing the ringing line's button. The intercom call automatically disconnects.

USING A HEADSET

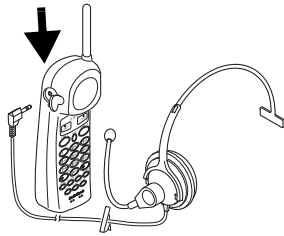

You can make or answer calls with handsfree convenience using an optional headset (available at your local RadioShack store) that has a $\frac{3}{32}$ -inch (2.5 mm) plug.

To connect the headset, pull open the rubber cover on the side of the handset, then insert the $\frac{3}{32}$ -inch (2.5 mm) plug into the jack.

Notes:

- Connecting a headset disconnects the handset's earpiece and microphone, but it does not affect the phone's speakerphone.
- **VOLUME** on the handset also controls the connected headset's volume.
- If you place the handset on the base facedown to recharge it while the headset is connected, be sure the handset seats properly.

With a headset connected, you can make or answer calls as usual, using the keys on the handset.

You can use a handset holder (available from your local RadioShack store) to hang the handset on your belt for greater convenience.

When you finish using the headset, disconnect it from the handset and close the rubber cover to protect the jack.

□ Memory Operation

You can store up to 10 numbers in the memory, then dial a stored number by pressing a single digit memory location number.

STORING A NUMBER IN MEMORY

Notes:

- An error tone sounds and the phone exits the storing process if you wait more than 20 seconds between key presses.

- Each number you store can be up to 16 digits long.

1. Lift the handset.
2. Press **MEM**. Both the line indicators on the handset flash.
3. Enter the number and any tone or pause entries (see "Using Tone Services On a Pulse Line" on Page 19 or "Entering a Pause" on Page 21).

Note: Each tone or pause entry uses one digit of memory.

4. Press **MEM**, then enter the memory location number (0–9) where you want to store the number. The tone sounds to indicate that the number is stored.

Note: If the phone sounds five quick beeps, you have made an entry error and the number was not stored. Re-enter the location number correctly.

5. Repeat the steps to enter more numbers.

To replace a stored number, simply store a new one in its place. To erase a number for a memory location, press **MEM** twice. Then press the memory location number (0–9) you want to clear. A tone sounds.

Entering a Pause

In some telephone systems, you must dial an access code (9, for example) and wait for a second dial tone before you can dial an outside number. You can store the access code with the phone number. However, you should also store a pause after the access code to allow the outside line time to connect. For each 2-second pause you want to enter, press **REDIAL**.

DIALING A MEMORY NUMBER

To dial a number stored in the memory, lift the handset from the base and press **LINE 1** or **LINE 2**. Then press **MEM** and the location number (0–9) by pressing a number key. The phone automatically dials the number.

Chain-Dialing Service Numbers

For quick recall of numbers for special services (such as alternate long distance or bank by phone), store each group of numbers in its own memory location.

To use the stored special service numbers, dial the service's main number first. Then, at the appropriate place in the call, press **MEM** and the number for the memory location where the additional information is stored.

Testing Stored Emergency Numbers

If you store an emergency service's number (police department, fire department, ambulance) and you choose to test the stored number, make the test call during the late evening or early morning hours to avoid peak demand periods. Also, remain on the line to explain the reason for your call.

□ **TAD Operation**

SELECTING THE OUTGOING MESSAGE

The phone has two prerecorded outgoing messages. One asks the caller to leave a message: "Hello, no one is available to take your call. Please leave a message after the tone." The phone uses this message when **REC TIME** is set to **1** or **4** (see "Setting the Record Time").

The other is simply an announcement and does not let the caller leave a message: "Hello, no one is available to take your call." The phone uses this message when **REC TIME** is set to **ANN** (announcement only).

You can also record your own message (see "Recording/Deleting an Outgoing Message"). When you record your own outgoing message, the phone uses it for all **REC TIME** settings.

To switch between your outgoing message and the phone's prerecorded message, repeatedly press **MSG LINE SELECT** until the line indicator for the desired line lights in the message counter window, then press **OGM**. When the current message begins to play, press **OGM** again. The phone switches to the other message and plays it. The display shows **P** for prerecorded message or **U** for your own message.

RECORDING/DELETING AN OUTGOING MESSAGE

You can record different messages for each line. Press **MSG LINE SELECT** so the line indicator for the desired line lights in the message counter window. Hold down **OGM** until the phone beeps and the message counter window starts counting. Then speak your outgoing message (up to 30 seconds long) into the built-in microphone on the bottom of the base. You can see how long your message is by watching the message counter window.

When you finish your message, press **PLAY/STOP** or **OGM**. The phone plays back your message.

To delete your outgoing message and use the phone's prerecorded messages, hold down **OGM** until the phone beeps. Then press **OGM** again within two seconds.

SETTING THE RECORD TIME

Set **REC TIME** to **1**, **4**, or **ANN** to determine how the phone will record incoming messages for each line.

1 — The phone plays the outgoing message and lets callers leave a message up to 1 minute long.

4 — The phone plays the outgoing message and lets callers leave a message up to 4 minutes long.

ANN (announcement only) — The phone plays the outgoing message but does not let callers leave a message.

SETTING THE PHONE TO ANSWER CALLS

To set the phone to answer calls, repeatedly press **MSG LINE SELECT** until the line indicator for the desired line lights in the message counter window, then press **ANSWER**. If the phone is set to record a caller's message (see "Setting the Record Time" on Page 22), it plays the outgoing message and shows the number of recorded messages. If the phone is set to announcement-only, it plays the outgoing message, and **A** appears.

Note: If the incoming message memory is full, the phone announces, "No remaining time."

To set the phone to not answer calls, press **MSG LINE SELECT** so the line indicator for the desired line lights in the message counter window, then press **ANSWER**. The phone announces "Answer off" and the message counter turns off.

SCREENING CALLS

You can let the phone answer calls for you while you listen to the caller's message through the base's speaker. If you decide to answer the call, press **LINE 1** or **LINE 2** on either the base or the handset to answer. You can also pick up any phone on the same line. The phone stops recording and resets to answer the next call.

Note: When you receive a call on one line while you are using the speakerphone on the other line, the call screening function does not operate.

RECORDING INCOMING MESSAGES

After the phone answers a call, it plays the outgoing message, beeps, and records the caller's message.

Each incoming message can be up to 1 or 4 minutes long, depending on how you set **REC TIME** (see "Setting the Record Time" on Page 22). The phone's maximum recording capacity for both lines is 25 minutes or 59 messages.

Note: When the phone receives a call on one line while it is answering on the other, it answers the new call after recording the first call.

The phone stops recording and resets to answer the next call when:

- the caller hangs up
- the maximum message length is reached
- the phone detects a busy signal or more than 7 seconds of silence
- you pick up the call on any phone on the same phone line

Note: When the phone's message memory is full, **FL** appears on both message counters and the phone announces "No remaining time" when you try to operate it.

RECORDING A MEMO

A memo is a message you can record at the phone for yourself or others in your home or office. The phone stores memos as incoming messages on the selected line (see “Playing Messages”).

To record a memo, press **MSG LINE SELECT** so the line indicator for the desired line lights in the message counter window. Hold down **MEMO** on the base until the phone beeps and starts counting in the message counter window, then speak your message. When you finish the memo, press **PLAY/STOP** or **MEMO**.

Notes:

- The maximum length for recording a memo is 10 minutes.
- The phone cannot record a memo less than two seconds long.
- If you receive an incoming call or page from the handset, the phone exits the memo recording mode.
- You cannot record a memo while the phone is answering the other line.

RECORDING A CONVERSATION

The phone lets you record both sides of a telephone conversation.

Important Note: It is illegal in some areas to record a conversation without the consent of all parties to the conversation, including the phone company. Check the laws in your area before you use the two-way recording feature.

To start recording a phone conversation, repeatedly press **MSG LINE SELECT** until the line indicator for the line you are talking on lights in the message counter window. Then press **MEMO** on the base. The phone beeps and the message counter window starts counting. To stop recording, press **PLAY/STOP** or **MEMO**.

The phone stores a recorded conversation as a message on the selected line (see “Playing Messages”).

Notes:

- The maximum length for recording a conversation is 10 minutes.
- The phone cannot record a conversation less than two seconds long.
- When you want to record a conference call using both **LINE 1** and **LINE 2**, you can select either line with **MSG LINE SELECT**.
- You cannot record a conversation when the telephone is answering on the other line.

PLAYING MESSAGES

After the phone has recorded a message, its message counter shows the total number of messages stored. If you have new messages, the number flashes.

To play your messages, repeatedly press **MSG LINE SELECT** until the line indicator for the desired line lights in the message counter window, then press **PLAY/STOP**. The phone announces the number of new and old messages, then plays the new messages. The message

number appears as each message plays, and the phone announces the day and time of the call at the end of each message.

To play all messages after playing the new messages, press **PLAY/STOP** again. To skip to the next message, press **SKIP** during playback. If you know the message number of the one you want to hear, hold down **SKIP** until the desired number appears.

To replay the current message from the beginning, press **REPEAT**. If you press **REPEAT** within about 2 seconds (4 seconds during remote operation) after a message begins playing, the phone replays the previous message.

If you know the message number of the one you want to hear, hold down **REPEAT** until the desired number appears.

ADJUSTING THE TAD'S VOLUME

To adjust the speaker's volume, repeatedly press **VOLUME ▲** or **VOLUME ▼** on the base. The volume setting from **1** (lowest) to **10** (highest) appears in the message counter window.

DELETING MESSAGES

To delete the current message while it is playing, press **DELETE**. The phone beeps.

To delete all messages on either line at once, repeatedly press **MSG LINE SELECT** until the line indicator for the desired line lights in the message counter window. Then, while messages are not playing, hold down **DELETE** on the base

until the phone beeps and **0** appears in the message counter window.

Note: You cannot delete new (unplayed) messages. If you try to delete all messages at once while you still have new messages, the phone sounds a long beep and deletes old messages only.

SETTING THE REMOTE OPERATION PIN

The phone's two-digit remote operation PIN (personal identification number) prevents unauthorized remote access to your messages. The PIN is preset to **80**.

Follow these steps to change the PIN to any number from **00** to **99**. The PIN is common to both lines.

Note: If you wait more than 2 minutes between each keypress, the phone exits the PIN setting process. Start again at Step 1.

1. Hold down **PIN** until the phone beeps and **00** appears in the message counter window.
2. Press **SKIP** to set the first digit of the PIN higher or **REPEAT** to set it lower. Then press **PIN**.
3. Press **SKIP** or **REPEAT** to set the second digit of the PIN, then press **PIN**. The phone announces the new PIN.
4. To check your PIN at any time, press **PIN**. The PIN appears in the message counter window, and the phone announces it.

□ Remote Operation

While you are away from your home or office, you can use a touch-tone phone, or a pulse (rotary) phone with a pocket tone dialer (available through your local RadioShack store) to enter your PIN and do any of the following:

- set the phone to answer or not answer calls
- listen to your messages
- record a new outgoing message
- erase messages
- monitor the room where the phone is located

Notes:

- You cannot remotely operate the phone using its handset or another telephone on the same line as the phone.
- You can also listen to the message recorded on Line 2 by making a call to Line 1's number (or vice versa).

USING THE TOLL-SAVER

If **RING TIME** is set to **TS** (toll-saver), (see "Setting the Number of Rings" on Page 15), the phone answers after three rings if you have new messages (ones you have not listened to). If there are no new messages, the phone answers after five rings. This gives you time to hang up before the phone answers so you can avoid unnecessary long-distance charges.

Note: Toll-saver works only on the line you called. If Line 1 has no new messages, but Line 2 has one, the telephone answers after five rings when you call Line 1.

USING REMOTE COMMANDS

Follow these steps to operate the phone from a remote location.

Note: If you wait more than 15 seconds between keypresses, the phone sounds a long beep and hangs up.

1. Dial your phone number and wait for the phone to answer.
2. If the phone is not set to answer calls, it answers after about 10 rings and sounds a series of beeps.
3. When the outgoing message begins (or the phone sounds a series of beeps), press #, then enter your PIN within 2 seconds.

If the PIN is correct, the phone announces the day and time, then it announces the number of new and old messages. The phone plays all new messages, then beeps about every two seconds to let you know it is ready to accept remote commands.

Notes:

- If the phone does not respond, try entering your PIN again. If you enter an incorrect PIN three times, the phone beeps and hangs up.

- When the phone is operating from a remote location, it stops all answering functions and **RC** appears on the display on the base. The phone resumes answering functions when it is no longer in remote operation, if you have not turned it off.
- The remote playback of incoming messages is limited to 4 minutes. If you have more messages after 4 minutes have passed, you must press **# 2** again to listen to the rest of the messages.
- When using remote operation, you can only delete the current message during playback. You cannot delete all the messages stored at one time.

The following table shows the remote commands you can use.

Note: Remote operation stops when someone picks up the handset and presses either **LINE 1** or **LINE 2** (whichever is flashing), or any phone on the same phone line.

Remote Commands

Press # then (within 2 seconds:	Function
1	Repeat current message during playback.
2	Play messages.
3	Skip current message during playback.
4	Delete current message during playback.
5	Stop playback, recording, and room monitoring.
6	Set the phone to answer or not answer calls.
7	Record or stop recording a new outgoing message.
8	Play the outgoing message.
9	Switch to the other line (Line 1 or Line 2).
0	Monitor the room where the phone is located for 15 seconds.

Troubleshooting

We do not expect you to have any problems with your phone, but if you do, the following suggestions might help.

Problem	Suggestion
The phone does not work or works poorly.	<ul style="list-style-type: none">• Be sure the base's phone line cord and AC adapter are correctly and securely connected.• Be sure the handset's battery pack is charged.• Return the handset to the base for a few seconds to reset the security-access protection code.
The handset stops working or works poorly during a call.	<ul style="list-style-type: none">• Move the handset closer to the base.• Lift the base's antenna to a vertical position.• Be sure the handset's battery pack is charged.
Low volume or unusual sounds.	<ul style="list-style-type: none">• Someone has picked up another phone on the same line. Hang up the other phone.
Severe noise interference.	<ul style="list-style-type: none">• Keep the handset and base away from computers, remote control toys, wireless microphones, alarm systems, intercoms, room monitors, fluorescent lights, and electrical appliances.• Move to another location or turn off the source of interference.• Press CH to change the channel.• Hang up and redial the number.
The phone cannot be operated at a useful distance from the base because the signal becomes weak or noisy (handset's range has decreased).	<ul style="list-style-type: none">• Lift the base's antenna to a vertical position.• Be sure neither antenna is touching a metal surface.• Recharge the battery pack.
The handset battery pack does not charge.	<ul style="list-style-type: none">• Check the charging contacts on the handset and base. If they are dirty, clean them with a pencil eraser.• Be sure the handset is properly seated on the base.• Replace the battery pack (see "Replacing the Battery Pack" on Page 30).

Problem	Suggestion
Handset does not ring or receive a page.	<ul style="list-style-type: none"> • Lift the base's antenna to a vertical position. • Move the handset closer to the base. • Move the handset and base away from other electrical devices. • Recharge the battery pack.
The TAD does not answer calls.	<ul style="list-style-type: none"> • Make sure the TAD is turned on. • Make sure the AC adapter is properly connected. • Check all phone line connections.
The TAD does not record callers' messages.	<ul style="list-style-type: none"> • REC TIME is set to ANN (announcement only). Set it to 1 or 4. • Delete message if memory is full.
E E flashes.	<ul style="list-style-type: none"> • Microprocessor failure. Disconnect the AC adapter, wait 15 seconds, then plug in the adapter again.

If the base loses power while the handset is off of it, the security access-protection code might change. Restore power to the base, then place the handset back on the base and leave it there for a few seconds.

If you still have problems, disconnect the phone. If other phones on the same line work properly, the fault is in this phone or its installation. If you cannot find the problem, take your phone to your local RadioShack store for assistance.

Care

To enjoy your RadioShack 2-Line 900 MHz Cordless Answering System for a long time:

- Keep the telephone dry. If it gets wet, wipe it dry immediately.
- Use and store the telephone only in normal temperature environments.
- Handle the telephone gently and carefully. Do not drop it.
- Keep the telephone away from dust and dirt.
- Wipe the telephone with a damp cloth occasionally to keep it looking new.

Modifying or tampering with the telephone's internal components can cause a malfunction and might invalidate its warranty and void your FCC authorization to operate it. If your telephone is not performing as it should, take it to your local RadioShack store for assistance. If the trouble is affecting the telephone lines, the phone company can ask you to disconnect your telephone until you have resolved the problem.

REPLACING THE BATTERY PACK

If you follow the instructions in "Connecting and Charging the Battery Pack" on Page 13, the battery pack should last about one year. If the battery pack does not hold a charge for more than 2 hours after an overnight charge, replace it with a 600 mAh battery pack with a connector that fits the socket in the battery compartment. You can order a replacement battery pack through your local RadioShack store.

Install the new battery pack as described below, then charge it for about 24 hours (see "Connecting and Charging the Battery Pack" on Page 13).

Note: To avoid losing memory numbers, install and begin charging the new battery pack within 2 minutes.

1. Press down and slide off the battery pack compartment cover.
2. Lift the battery pack out of the compartment, then gently pull on the battery connector to disconnect it.

3. Insert the new battery pack's connector into the socket in the compartment, place the battery pack into the compartment.
4. Replace the cover.

If you have trouble replacing the battery pack, take the phone to your local RadioShack store for assistance.

Cautions:

- You must use a replacement battery of the same size and type.
- Do not dispose of the battery in a fire because it might explode.
- Do not open or mutilate the battery.
- Be careful not to short the battery by touching the connector's pins with conducting materials, such as rings, bracelets, and keys. The battery pack or conductor might overheat and burn.

Important: This telephone can use nickel-cadmium rechargeable batteries. At the end of a nickel-cadmium battery's useful life, it must be recycled or disposed of properly. Contact your local, county, or state hazardous waste management authorities for information on recycling or disposal programs in your area or call 1-800-843-7422. Some options that might be available are: municipal curbside collection, drop-off boxes at retailers such as your local RadioShack store, recycling collection centers, and mail-back programs.



THE FCC WANTS YOU TO KNOW

In the unlikely event that your phone causes problems on the phone line, the phone company can temporarily discontinue your service. If this happens, the phone company attempts to notify you in advance. If advance notice is not practical, the phone company notifies you as soon as possible and advises you of your right to file a complaint with the FCC.

Also, the phone company can make changes to its lines, equipment, operations, or procedures that could affect the operation of this telephone. The telephone company notifies you of these changes in advance, so you can take the necessary steps to prevent interruption of your telephone service.

LIGHTNING

Your telephone has built-in protection circuits to reduce the risk of damage from surges in telephone line and power line current. These protection circuits meet or exceed the FCC requirements. However, lightning striking the telephone or power lines can damage your telephone.

Lightning damage is not common. Nevertheless, if you live in an area that has severe electrical storms, we suggest that you unplug your phone when storms approach to reduce the possibility of damage.

Limited One-Year Warranty

This product is warranted by RadioShack against manufacturing defects in material and workmanship under normal use for one (1) year from the date of purchase from RadioShack company-owned stores and authorized RadioShack franchisees and dealers. EXCEPT AS PROVIDED HEREIN, RadioShack MAKES NO EXPRESS WARRANTIES AND ANY IMPLIED WARRANTIES, INCLUDING THOSE OF MERCHANTABILITY AND FITNESS FOR A PARTICULAR PURPOSE, ARE LIMITED IN DURATION TO THE DURATION OF THE WRITTEN LIMITED WARRANTIES CONTAINED HEREIN. EXCEPT AS PROVIDED HEREIN, RadioShack SHALL HAVE NO LIABILITY OR RESPONSIBILITY TO CUSTOMER OR ANY OTHER PERSON OR ENTITY WITH RESPECT TO ANY LIABILITY, LOSS OR DAMAGE CAUSED DIRECTLY OR INDIRECTLY BY USE OR PERFORMANCE OF THE PRODUCT OR ARISING OUT OF ANY BREACH OF THIS WARRANTY, INCLUDING, BUT NOT LIMITED TO, ANY DAMAGES RESULTING FROM INCONVENIENCE, LOSS OF TIME, DATA, PROPERTY, REVENUE, OR PROFIT OR ANY INDIRECT, SPECIAL, INCIDENTAL, OR CONSEQUENTIAL DAMAGES, EVEN IF RadioShack HAS BEEN ADVISED OF THE POSSIBILITY OF SUCH DAMAGES.

Some states do not allow limitations on how long an implied warranty lasts or the exclusion or limitation of incidental or consequential damages, so the above limitations or exclusions may not apply to you.

In the event of a product defect during the warranty period, take the product and the RadioShack sales receipt as proof of purchase date to any RadioShack store. RadioShack will, at its option, unless otherwise provided by law: (a) correct the defect by product repair without charge for parts and labor; (b) replace the product with one of the same or similar design; or (c) refund the purchase price. All replaced parts and products, and products on which a refund is made, become the property of RadioShack. New or reconditioned parts and products may be used in the performance of warranty service. Repaired or replaced parts and products are warranted for the remainder of the original warranty period. You will be charged for repair or replacement of the product made after the expiration of the warranty period.

This warranty does not cover: (a) damage or failure caused by or attributable to acts of God, abuse, accident, misuse, improper or abnormal usage, failure to follow instructions, improper installation or maintenance, alteration, lightning or other incidence of excess voltage or current; (b) any repairs other than those provided by a RadioShack Authorized Service Facility; (c) consumables such as fuses or batteries; (d) cosmetic damage; (e) transportation, shipping or insurance costs; or (f) costs of product removal, installation, set-up service adjustment or reinstallation.

This warranty gives you specific legal rights, and you may also have other rights which vary from state to state.

RadioShack Customer Relations, 200 Taylor Street, 6th Floor, Fort Worth, TX 76102

We Service What We Sell

12/99

RadioShack
A Division of Tandy Corporation
Fort Worth, Texas 76102

43-681
UCZZ01266BZ
09A00
Printed in China