

MPA-45 35-WATT AC/MOBILE  
PA AMPLIFIER SHEET # 1 (320-2035)  
FAXBACK DOC # 11433

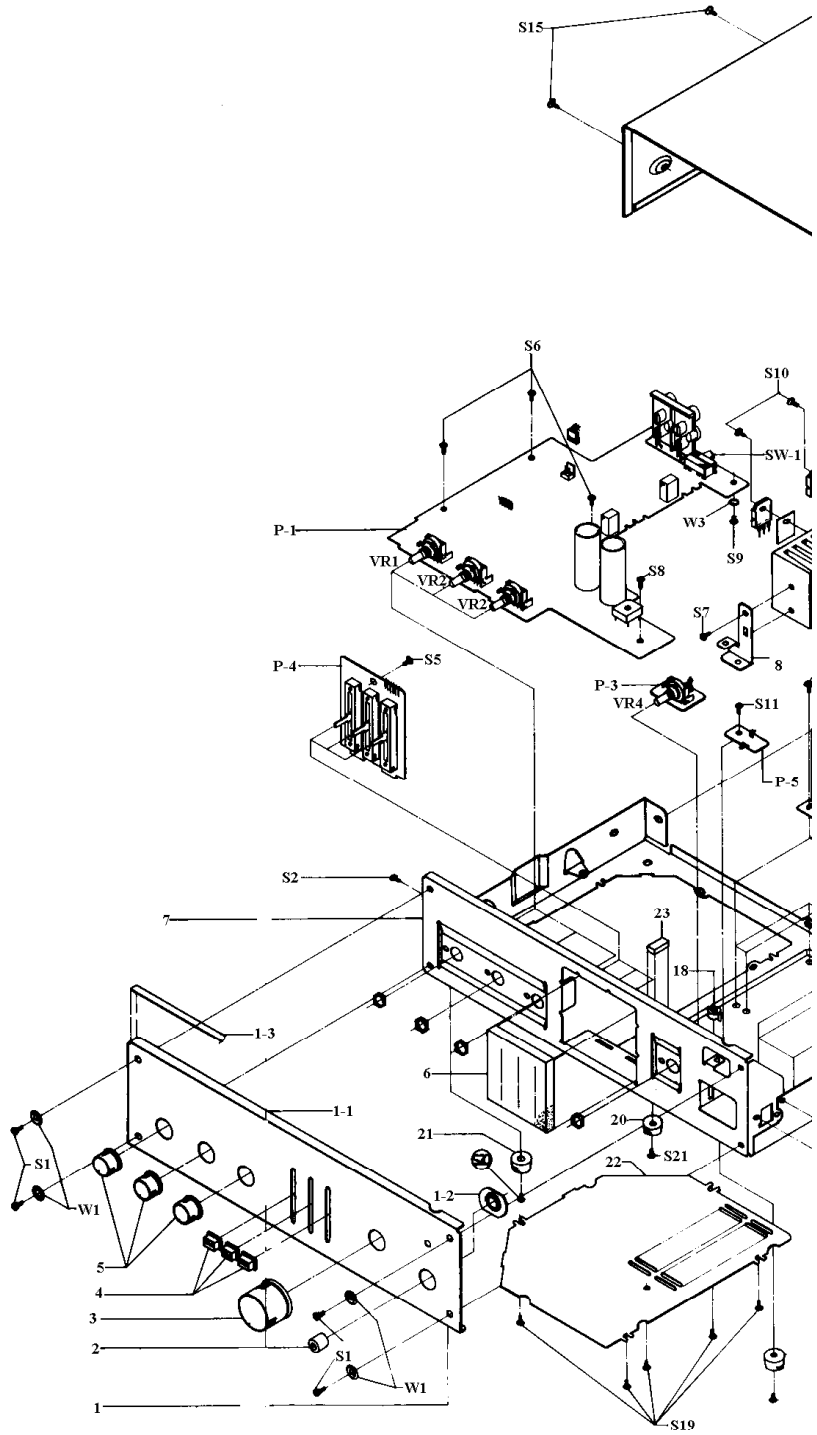

MPA-45 35-WATT AC/MOBILE  
PA AMPLIFIER SHEET #2 (320-2035)  
FAXBACK DOC # 11433

